

DATA SHEET

General Characteristics

Standardcharge

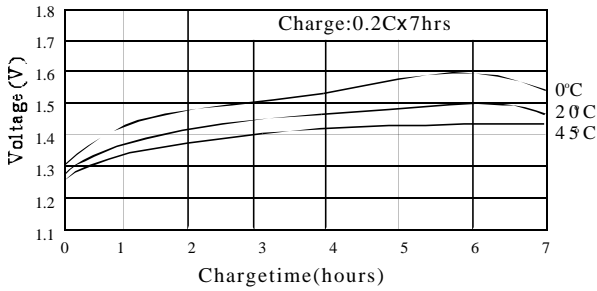

Fastcharge

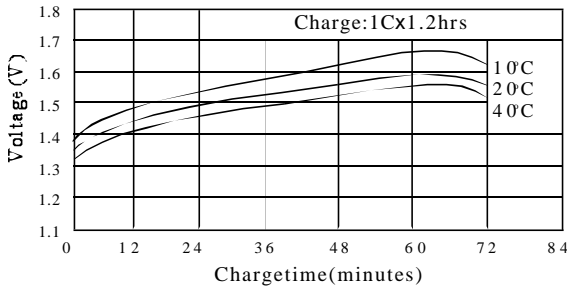

Dischargecharacteristicat 20°C

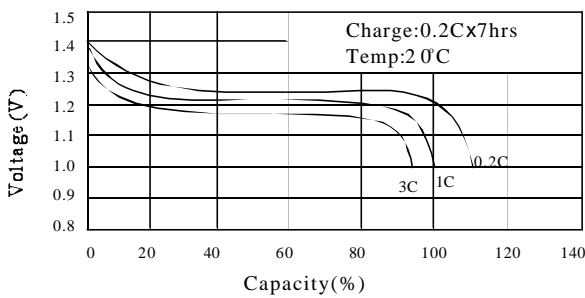

Cycle life

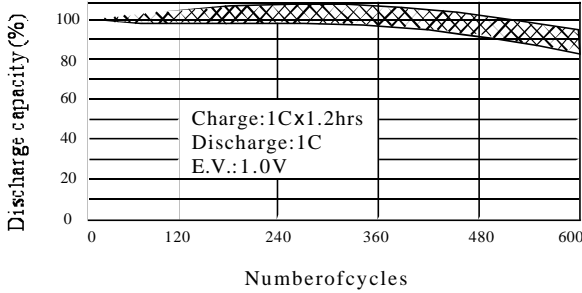

Specifications

Nominal Voltage		1.2V	
Capacity (mAh)		C/5	1C
	Nominal	1800	1600
	Typical	2000	1800
Dimension	Diameter	16.5 ± 0.2mm	
	Height	42.2 ± 0.3mm	
Approx Weight		35g	
Internal Resistance (at 1KHz)		≲ 20mΩ (full charged)	
Charge	Standard	360mA x 7hrs	
	Fast	1800mA x 1.2hrs	
	Trickle	5490mA	
Discharge Cut-off Voltage		1.0V	
Cycle Life		≳ 500	
Ambient Temperature	Standard Charge	0-50°C	
	Fast Charge	1-50°C	
	Trickle Charge	0-45°C	
	Discharge	-20-60°C	
	Storage	-20-45°C	
Relative Humidity		65 ± 20%	

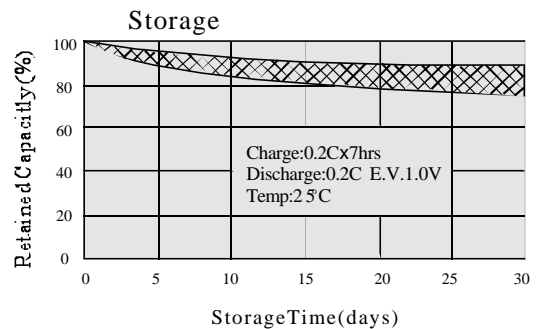
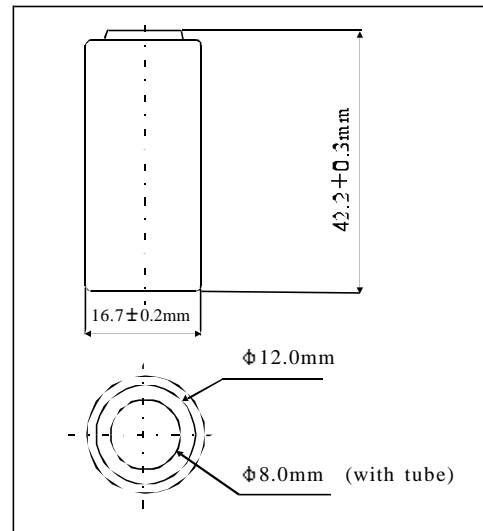

Note:

- 1. Nominal capacity rated at C/5, 20°C
- 2. Other capacities are for reference.
- 3. Weight and internal resistance are for reference.